

CONFIGURATION HANDBOOK

CPL101



LOREME 12, rue des Potiers d'Etain Actipole BORNLY - B.P. 35014 - 57071 METZ CEDEX 3
Phone 03.87.76.32.51 - Fax 03.87.76.32.52
Contact : Commercial@Loreme.fr - Technique@Loreme.fr
Download manual at : www.loreme.fr

DEVICE PRESENTATION	p4
RS232 Link setting	p5
Terminal mode	p6
1) Visualization	p6
2) Configuration	p7
2.1) Method	p7
2.1.1) Menu selection	p7
2.1.2) Parameter select	p7
2.1.3) Value acquisition	p7
2.2) Language	p7
2.3) Network	p7
2.4) Energy	p8
2.5) Relay	p8
2.5.1) Alarm	p8
2.5.2) Counting	p8
2.6) Analog output	p9
2.7) Communication	p9
WIRING FUNCTIONS	p10
1) Balanced three-phase	p10
1.1) Operating mode	p10
1.2) Method	p10
2) Unbalanced three-phase without neutral	p10
2.1) Operating mode	p10
2.2) Method	p11
3) Unbalanced three-phase with neutral	p11
3.1) Operating mode	p11
3.2) Method	p11
EMC CONSIDERATION	p13
1) Introduction	p13
2) Recommendations of use	p13
2.1) General remarks	p13
2.2) Power supply	p13
2.3) Input / output	p13
DIAGRAMS OF CONNECTION	p14
1) Single phase	p14
2) Balanced three-phase with neutral	p14
3) Balanced three-phase without neutral	p14
4) Unbalanced three-phase	p15
5) Unbalanced three-phase without neutral, 2 wattmeter method	p16
RS232 / DEVICE LINK	p17
RS485 MODBUS COMMUNICATION	p18
1) Internal structure	p18
1.1) Presentation	p18
1.2) Measure function	p18
1.3) Communication function	p18
1.4) System memory	p18
2) Communication	p18
3) Implementation	p19
3.1) Parameters	p19
3.2) Interconnection	p19
4) Communication time	p20
4.1) Procedure	p20
4.2) Phase measures reading	p20

Table of contents

4.3) Energies reading	p20
4.4) Reset energies	p21
5) Structure of frames	p21
5.1) Word reading	p21
5.2) Word writing	p21
5.3) Exception frame	p22
6) Data	p22
6.1) Reading	p22
6.2) Writing	p22
6.3) Data format	p22
7) Measures tables	p23
7.1) Phase 1 measures	p23
7.2) Phase 2 measures	p24
7.3) Phase 3 measures	p24
7.4) Sum of phases	p25
7.5) Active consumed energies, reactive inductive	p25
7.6) Active generated energies, reactive capacitive	p25

Device presentation

The purpose of this configuration handbook allows to become familiar with the functions supplied by the device. The CPL101 is provided of functions required to analysis of every networks. It owns 3 voltage inputs and 3 current inputs isolated allowing to realize single phase or three-phase measures, balanced or unbalanced, with or without neutral.

It is necessary to notice the differences between models:

- CPL101: standard version, 2 analog outputs, 1 relay for alarm or counting.
- CPL101/C: standard version + 1 RS485 link Modbus/Jbus protocol
- CPL101T: fast version (100ms), 2 analog outputs
- CPL101T/S3; fast version (100ms), 3 analog outputs

The technical data sheet is downloadable here: http://www.loreme.fr/fichtech/CPL101_eng.pdf

USER INTERFACE

9 pin SUB-D
for RS232

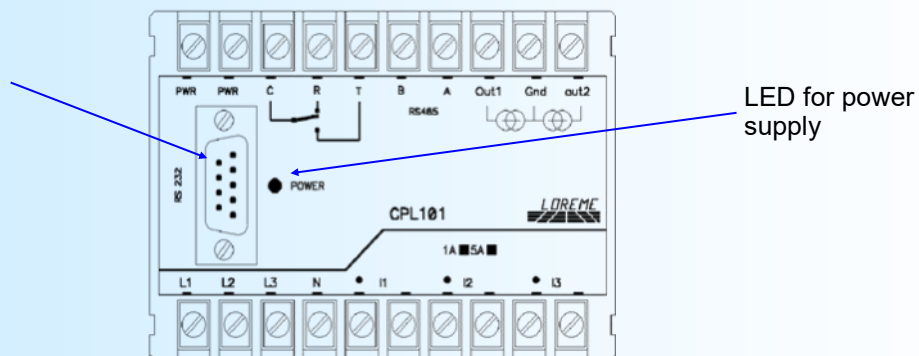

LED for power
supply

RS232 link setting

The device can be updated in terminal mode via an RS232 link.

Step 1: Driver installation for USB / RS232 adapter



- download driver at www.loreme.fr:
http://www.loreme.fr/aff_produits.asp?rubid=53&langue=fr
- Click on executable file to install the driver,
- Plug the cable on a USB port, Windows install a new serial communication port **COMx** (x >= 4).

Note:

The use of the cable on another USB port don't generates a new communication port. Use of another adapter generates another communication port number (COMx) and requires the reconfiguration of the HyperTerminal.

Step 2: Setting of terminal emulation software (PC with Windows).

1 The terminal emulation software for PC « HyperTerminal » is resident in windows up to XP version. For later versions, it is downloadable on : www.loreme.fr in **download part** (<http://www.loreme.fr/HyperTerm/htpe63.exe>)
=> Run the downloaded software to install it.

2 Start a "hyper Terminal" connection :
- Click on **"START"** button
Up to XP version
- Go to **"Programs \ Accessories \ Communication \ Hyper Terminal"**
- Click on **"Hypertrm.exe"**
Or if the software was downloaded
- Go to **"All programs \ HyperTerminal Private Edition"**
- Click on **"HyperTerminal Private Edition"**

3 Enter name for the new connection

4 Choose the communication port related to the adapter.

5

Choose:
- 9600 bauds
- 8 DATA bits
- no parity
- 1 stop bit
- **XON/XOFF**

6 The PC is now in terminal mode, connect it to the device by plugging the RS232 cable. The measure is now displayed on the terminal. To access configuration, press 'C' key.

7 When leaving Hyper terminal, the following window will appear. By saving, the terminal session will start with the same configuration.

Thus, the shortcut  **LOREME.ht** will permit to communicate with all LOREME devices.

Note: to modify the parameters of terminal mode whereas this one is already started, it is necessary, after having carried out the modifications, to close the terminal and to open it again so that the modifications are effective.

Terminal mode

1) Visualization

At the power on, the device is automatically in measure mode.
2 mode of visualization are available:

- **2 lines mode** : display only one measure.
- **Full screen mode** : **display all measures**.

The following short key are used to change the display mode:

"%" full screen (PC under windows).
"\$" full screen (PC under DOS).
"Enter" back to 2 lines mode.

In 2 lines mode, the following keys are active:

"space" change the displayed measure,
"1" phase 1 measures,
"2" phase 2 measures,
"3" phase 3 measures,
"S" network measures (3L),

In 2 lines mode, the display looks like this:

```
P.ACTIVE 3L          Measure type and phase
2550 kW             measure value
```

In full screen mode, the display is:

	L1	L2	L3	3L
VOLTAGE	230 V	229 V	225 V	
	398 V	393 V	394 V	
CURRENT	1.13 A	1.26 A	1.24 A	
FREQUENCY	50.02 Hz	50.03 Hz	50.01 Hz	
COS PHI	0.999 C	0.999 C	0.999 C	0.999 C
ACTIVE P.	259 W	287 W	279 W	825 W
REACTIVE P.	3 var	4 var	2 var	9 var
APPARENT P.	260 VA	287 VA	279 VA	826 VA
ACTIVE CONS. W				150 kW.h
ACTIVE GENE. W				0 kW.h
REACTIVE IND. W				0 kvar.h
REACTIVE CAP. W				3 kvar.h
UNBALANCED THREE-PHASENETWORK WITH NEUTRAL				
TP RATIO	1.00			
CT RATIO	1.00			

Note:
 The full screen exploitation can be realized with PC in DOS mode (access jey "\$") or in windows mode (access key "%"). In windows mode, deselect self lines return in "Properties - parameter - ASCII configuration" for a better visualisation.
 The full screen mode slows the device, it is recommended to quit this mode when it is not necessary.

Terminal mode

2) Configuration

To access configuration mode, type on "C" key.

The device display:
CONFIGURATION
REV x.y

Device version : x = Hard revision, y = Soft revision.

2.1) Method

In configuration mode, some questions are displayed. For each cases, many answers are possible. This is the detailed description:

2.1.1) Menu selection

Example: NETWORK
(Y-N)

Use the "Y" or "N" keys for choose.

This choice allows to access to the other configuration menu.

2.1.2) Parameter select

Example: VOLTAGE or VOLTAGE
(Y-N) YES (Y-N) NO

Previous choice = YES: - "Y" or "Enter" keys => validate choice = YES,
- "N" key => change, choice = NO.

Previous choice = NO: - "N" or "Enter" keys => validate choice = NO,
- "O" key => change, choice = YES.

Choices are made by pushing on "Y" or "N" keys, and validation by pushing on displayed answer ("Y" for YES and "N" for NO) or by "Enter". Pushing on the "Enter" key without modification allows to validate previous answer.

2.1.3) Value acquisition

Example: LOW SCALE
4 mA

Two possibilities:

- The validation without modification by pushing on "Enter",
- The modification with simultaneous display followed by validation with "Enter" key.

It is possible, when a mistake is made during a value acquisition, before validating it, to go back by pressing on "©" (backspace). This re-displays the message without taking notice of the mistake.

Notes:

- In configuration mode, if there is no action during 2 minutes, device goes back to operating mode without taking notice of the modifications made before.
- In configuration mode, if you want to shift to measure mode without taking notice of modifications made before, just press "ESC" key.
- In configuration, the used phase choice depends of used value.
L1, L2 and L3 phases are individually available for voltages, currents, frequency, power and cos phi.
L1, L2 and L3 phases sum is available for power, cos phi and energies.

2.2) Language

Languages possibilities are:

- French,
- English.

2.3) Network

The network configuration possibilities are:

- single phase (1 wattmeter),
- Balanced three-phase without neutral (1 wattmeter),
- Balanced three-phase with neutral (1 wattmeter),

- Unbalanced three-phase without neutral (2 wattmeter),
- Unbalanced three-phase with neutral (3 wattmeter).

It is also necessary to configure the CT and the PT ratios if inputs are not directly wired on network:

- PT ratio, potential transformer,
- CT ratio, current transformer.

Ex: Current transformer with 100A for primary and 5A for secondary.
CT ratio setting : primary / secondary = 20.

2.4) Energy

This menu gives the possibility to reset all energy counters.

Warning: All energies are definitely reset.

2.5) Relay

Tow function mode for relay:

- alarm,
- counting.

2.5.1) Alarm

The relay's configuration in alarm mode is composed of 2 rubrics:

- measures parameter:
 - measure monitored:
 - simple or interlink voltage (following network type),
 - current,
 - frequency,
 - cos phi,
 - active, reactive, apparent powers,
 - active, consumed or generated energy,
 - reactive, inductive or capacitive energy.
 - phase monitored:
 - phase L1,
 - phase L2,
 - phase L3,
 - network (sum of 3 phases L1-L2-L3).
- alarm parameters:
 - detection type, high or low alarm,
 - threshold,
 - hysteresis.

Alarm works in this way:

- **High alarm detection:**

- .Alarm is activated when the measure goes beyond the threshold,
- .Alarm is deactivated when the measure goes below threshold minus hysteresis.

- **Low alarm detection:**

- .Alarm is activated when the measure goes below the threshold,
- .Alarm is deactivated when measure goes beyond threshold plus hysteresis.

2.5.2) Counting

The relay configuration in counting mode is composed of 2 rubrics:

- measure parameter:
 - used counter:
 - active consumed energy,
 - reactive inductive energy,
 - active generated energy,
 - reactive capacitive energy.

- counting parameter:
 - pulse weight (kWh or kvarh).

2.6) Analog output

The 2 outputs dispose of the same configuration possibilities.
 The output configuration is composed of 2 rubrics:

- monitored measure:
 - measured value:
 - simple or interlink voltage (following network type),
 - current,
 - frequency,
 - cos phi,
 - active, reactive, apparent powers,
 - active, consumed or generated energy,
 - reactive, inductive or capacitive energy.
 - phase monitored:
 - phase L1,
 - phase L2,
 - phase L3,
 - network (sum of 3 phases L1-L2-L3).
 - measure range : Low and high scale.
- output parameters:
 - output type : voltage or current,
 - output range: low and high scale,
 - filter,
 - limitation.

The numeric filter allows to smooth an analog output which measure would be disrupted, fluctuating or exposed to interferences. The filter value correspond to measure number on witch output is meant:

$$\text{Output (t)} = \frac{\text{Measure (t-1)} \times (F-1) + \text{Measure (t)}}{F}$$

The limitation allows, for all measured signal value, to peak clip the output signal swing at configured scale.

2.7) Communication

The communication configuration is composed of 4 rubrics:

- device **address** on the communication network, 1 to 255,
- **baud rate**, 600, 1200, 2400, 4800, 9600, 19200, 38400 bauds,
- **parity** odd, even, none.
- **data format**, 32 bits floating IEEE, direct 32 bits integer (msb-lsb), reverse 32 bits integer (lsb-msb).

For more details, see the Modbus protocol description at the end of this handbook.

Wiring functions

Functions reserved for experienced users.

Function is only used for a balanced or unbalanced three-phase with or without neutral network. It allows a wiring adaptation at device operating mode. It is so possible to permute voltages and currents by a simple intervention on keyboard via the RS232 link. Several keys are used "1", "2", "3" to select phase to correct, "+" to permute phase order, "-" to reverse current direction, "Enter" to validate wiring.

1) Balanced three-phase

1.1) Operating mode

In this operating mode, the device uses only one voltage and one current (L1 and I1 input, see diagrams of connection). It measures voltage, current and frequency, calculates powers, cos phi, energy of measured phase and, according to the network configuration, with or without neutral, determinates finals results of the network (3L). The device allows to adapt itself to an existing wiring or to a bad identification of voltages and currents, that is to say that it can use L1, L2 or L3 voltage with I1, I2 or I3 current for a wiring with neutral or L12, L23 or L31 voltage with I1, I2 or I3 current for a wiring without neutral.

1.2) Method

The function is realized via the RS232 link. It's by the "Cos Phi" value visualization that user will be able to determinate if wiring is correct or if it must be modify.

The function start is realized with "+" or "-" keyboard keys. At this moment, the display on terminal becomes:

VISUALIZATION		DEFINITION
L1	-0.512 C 1 *	"L1" identify phase, "-0.512 C" is the cos phi value, "1" specifies using wiring type, "*" specifies corrected phase.
SELECT PHASE:	1, 2, 3	Selection of corrected phase,
CHANGE WIRING:	+	Wiring change,
REVERSE CURRENT:	-	Current reverse,
VALIDATE:	ENTER	Wiring validation.

The "1, 2, 3" keys allows to select corrected phase, in this way, only the phase 1 is measured. The "+" keys allows to modify wiring with insertion of phasing between voltage and current. The "-" key allows to reverse current direction if there is phase opposition (negative Cos Phi value). When Cos Phi value becomes coherent according to installation, you just have to validate selected wiring by "Enter" key. The wiring is memorized and remain active even after a power off.

In this operating mode, it exists 3 different wiring types. So, in few seconds and without intervention on connection, the device can be adapt to network.

2) Unbalanced three-phase without neutral

2.1) Operating mode

In this operating mode, device uses two voltages and two currents (L1, L2 and I1, I2 inputs, see diagrams of connection). It measures voltage, current and frequency, calculates powers, cos phi, energy of each of the two phases and determinates finals results of the network (3L).

The device allows to adapt itself to a bad identification of U/I couple of each phase. For instance, by default, device associates L1 input voltage, that's to say L13, with I1 input current and L2 input voltage, that's to say L23, with I2 input current. The wiring function allows to choose current/voltage association. So, it is possible to use L13 and L23 with I1 and I2 or L12 and L32 with I1 and I3 or L21 and L31 with I2 and I3. More, measure couples order will be able to be permuted.

The only wiring requirement is the use of voltage phase in which no current is measured as reference phase. It must be wired on voltage measure ground terminal. (L3 and N, see diagrams of connection). Whenever, a verification will be realized to inform user of a twice utilisation of one current or of one voltage, wiring no conformity.

2.2) Method

The function is realized via the RS232 link. It is by "Cos Phi" values visualization on phases 1 and 2 that user will be able to determinate if wiring is correct or if it must be modify.

The function start is realized by "+" or "-" keyboard keys.
At this moment, the visualization on terminal becomes:

VISUALIZATION				DEFINITION
L1	-0.512 C	1/1	*	"L1" identify phase, "-0.512 C" is the cos phi value, "1/1" associates L1 with I1, "*" specifies corrected phase.
L2	0.011L	2/2		
SELECT PHASE:		1, 2, 3		Selection of corrected phase,
CHANGE WIRING:		+		Wiring change,
REVERSE CURRENT:		-		Current reverse,
VALIDATE:		ENTER		Wiring validation.

The "1, 2, 3" keys allows to select corrected phase, in this way, phase 1 and 2 are measured. The "+" key allows to modify wiring by specifying current (I1 or I2) associated to voltage (L1 or L2). The "-" key allows to reverse current direction if there is phase opposition (negative Cos Phi value). When Cos Phi values become coherent according to installation, you just have to validate selected wiring by "Enter" key. The wiring is memorized and remain active even after a power off.

If the message "WIRING NO CONFORMITY" displays, it does mean that a current or a voltage has been used twice and that actual wiring is incorrect. It is so necessary to modify wiring by simply changing reference phase voltage (wired-up in L3-N).

In this operating mode, it exists for each phase 4 different wiring types. So, in few seconds and with a tiny intervention on voltage connection, device adapts itself completely to network.

3) Unbalanced three-phase with neutral

3.1) Operating mode

In this operating mode, device uses the three voltages and the three currents (L1, L2, L3 and I1, I2, I3 inputs, see diagrams of connection). It measures voltage, current and frequency, calculates powers, cos phi, energy for each of the three phases and determinates finals results of the network (3L).

The device allows to adapt itself to a bad identification of U/I couple of each phase. For instance, by default, device associates L1 input voltage with I1 input current, and the same for each phase. The wiring function allows to choose current/voltage association, that's to say that L1, L2 and L3 will be able to be associated with I1, I2 or I3 in the desire order. Whenever, a verification will be realized to inform user of twice utilisation of a current, wiring no conformity.

3.2) Method

The function is realized via the RS232 link. It's by a "Cos Phi" value visualization on phases 1, 2 and 3 that user will be able to determinate if wiring is correct or if it must be modify.

The function start is realized by "+" or "-" keyboard keys.
At this moment, the visualization of the terminal becomes:

VISUALIZATION				DEFINITION
L1	-0.512 C	1/1	*	"L1" identify phase, "-0.512 C" is the cos phi value, "1/1" associates L1 with I1, "*" specifies corrected phase.
L2	-0.511 C	2/2		
L3	-0.510 C	3/3		

SELECT PHASE:	1, 2, 3	Selection of corrected phase,
CHANGE WIRING:	+	Wiring change,
REVERSE CURRENT:	-	Current reverse,
VALIDATE:	ENTER	Wiring validation,

The "1, 2, 3" keys allows to select corrected phase, in this way, the 3 phases are measured. The "+" key allows to modify wiring by specifying the current (I1, I2or I3) associated to corrected phase voltage. The "-" key allows to reverse current direction if there is phase opposition (negative Cos Phi value). When Cos Phi values become coherent according to installation, you just have to validate selected wiring by "Enter" key. The wiring is memorized and remain active even after a power off.

If the message "WIRING NO CONFORMITY" displays, it does mean that a current has been used twice and that actual wiring is incorrect.

In this operating mode, it exists for each phase 3 different wiring types. So, in few seconds and without intervention on connection, device adapts itself completely to network.

EMC CONSIDERATION

1) Introduction

To meet its policy concerning EMC, based on the Community directives **2014/30/EU** & **2014/35/EU**, the LOREME company takes into account the standards relative to this directives from the very start of the conception of each product.

The set of tests performed on the devices, designed to work in an industrial environment, are made in accordance with **IEC 61000-6-4** and **IEC 61000-6-2** standards in order to establish the EU declaration of conformity. The devices being in certain typical configurations during the tests, it is impossible to guarantee the results in every possible configurations. To ensure optimum operation of each device, it would be judicious to comply with several recommendations of use.

2) Recommendations of use

2.1) General remarks

- Comply with the recommendations of assembly indicated in the technical sheet (direction of assembly, spacing between the devices, ...).
- Comply with the recommendations of use indicated in the technical sheet (temperature range, protection index).
- Avoid dust and excessive humidity, corrosive gas, considerable sources of heat.
- Avoid disturbed environments and disruptive phenomena or elements.
- If possible, group together the instrumentation devices in a zone separated from the power and relay circuits.
- Avoid the direct proximity with considerable power distance switches, contactors, relays, thyristor power groups, ...
- Do not get closer within fifty centimeters of a device with a transmitter (walkie-talkie) of a power of 5 W, because the latter can create a field with an intensity higher than 10 V/M for a distance fewer than 50 cm.

2.2) Power supply

- Comply with the features indicated in the technical sheet (power supply voltage, frequency, allowance of the values, stability, variations ...).
- It is better that the power supply should come from a system with section switches equipped with fuses for the instrumentation element and that the power supply line be the most direct possible from the section switch.
- Avoid using this power supply for the control of relays, of contactors, of electrogates, ...
- If the switching of thyristor statical groups, of engines, of speed variator, ... causes strong interferences on the power supply circuit, it would be necessary to put an insulation transformer especially intended for instrumentation linking the screen to earth.
- It is also important that the installation should have a good earth system and it is better that the voltage in relation to the neutral should not exceed 1V, and the resistance be inferior to 6 ohms.
- If the installation is near high frequency generators or installations of arc welding, it is better to put suitable section filters.

2.3) Inputs / Outputs

- In harsh conditions, it is advisable to use sheathed and twisted cables whose ground braid will be linked to the earth at a single point.
- It is advisable to separate the input / output lines from the power supply lines in order to avoid the coupling phenomena.
- It is also advisable to limit the lengths of data cables as much as possible.

Diagrams of connection

1) SINGLE PHASE

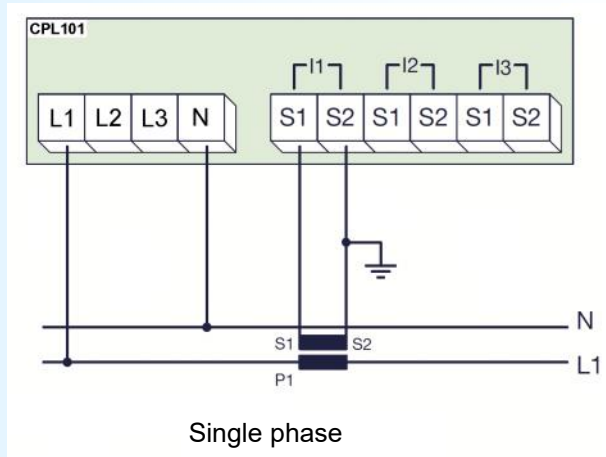

2) BALANCED THREE-PHASE WITH NEUTRAL

Default wiring with L1 / I1.

For use with other voltage or current, the "wiring" function can be used to adapt device to network.

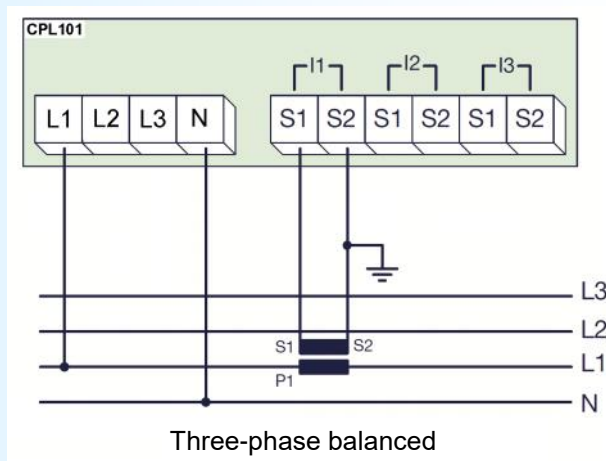

3) BALANCED THREE-PHASE WITHOUT NEUTRAL

Default wiring with L12 / I1.

For use with other voltage or current, the "wiring" function can be used to adapt device to network.

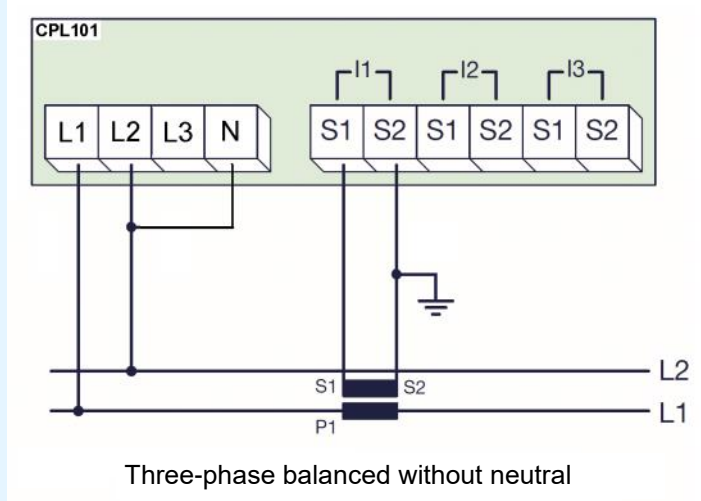

4) UNBALANCED THREE-PHASE WITH OR WITHOUT NEUTRAL

In all case, setting the device configuration for "**unbalanced three-phase WITH neutral**" (in this configuration, the device measure the 3 voltages and the 3 currents).
 In a network without neutral, link the 'N' pin to earth.

The default wiring is L1 / I1, L2 / I2 and L3 / I3. For use with other voltage or current, the "wiring" function can be used to adapt device to network.

4-A) WIRING WITH 3 CT

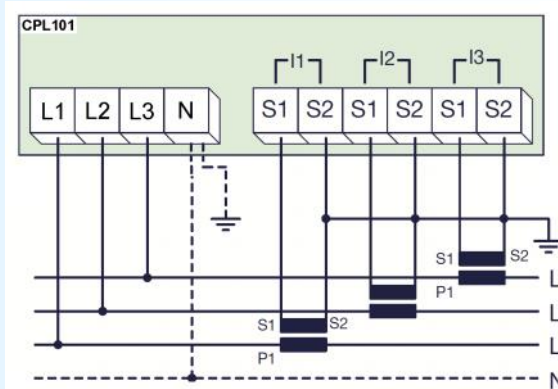

Unbalanced three-phase with 3 CT

4-B) WIRING WITH 2 CT (I1 AND I2)

Connect the CT according to this diagram. This makes it possible to reconstitute in a vector way the third current

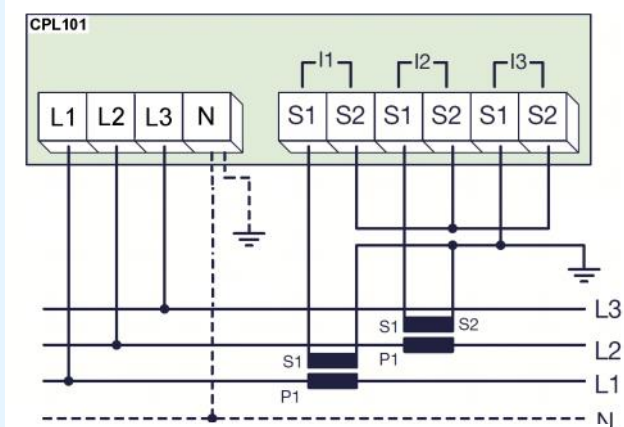

Unbalanced three-phase with I1 and I2

4-C) WIRING WITH 2 CT (I1 AND I3)

Connect the CT according to this diagram. This makes it possible to reconstitute in a vector way the third current

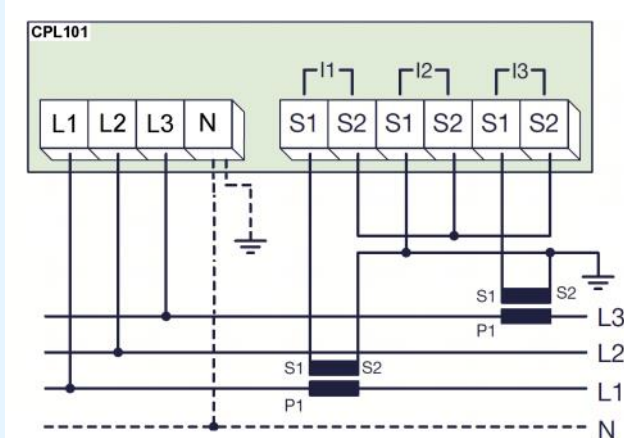

Unbalanced three-phase with I1 and I3

5) UNBALANCED THREE-PHASE WITHOUT NEUTRAL with then 2 wattmeter method

The device is configured for " Unbalanced three-phase without neutral". In this mode, the device measures 2 voltages (L1, L2) and 2 currents (I1 and I2).

The default wiring is L13 / I1, L23 / I2. It is required to wiring the reference voltage phase (phase on which no current is measured) to the pin L3-N.

For use with other voltage or current, the "wiring" function can be used to adapt device to network.

Note:
This method is a variant to wiring showing on page #14. This diagrams in page #14 however, remain preferable compared to the 2 wattmeter method.

WIRING WITH 2 CT (currents I1 and I2)

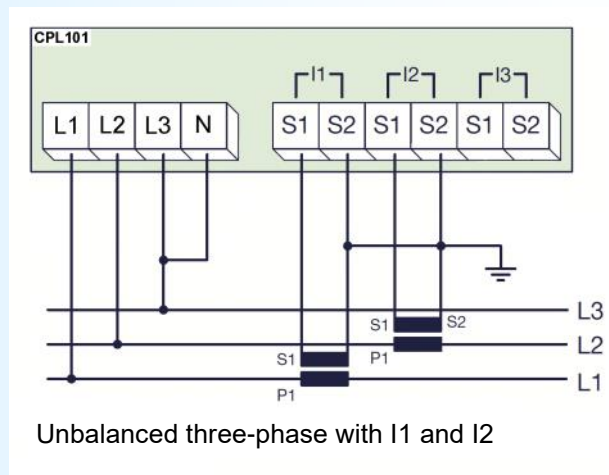

WIRING WITH 2 CT (currents I1 and I3)

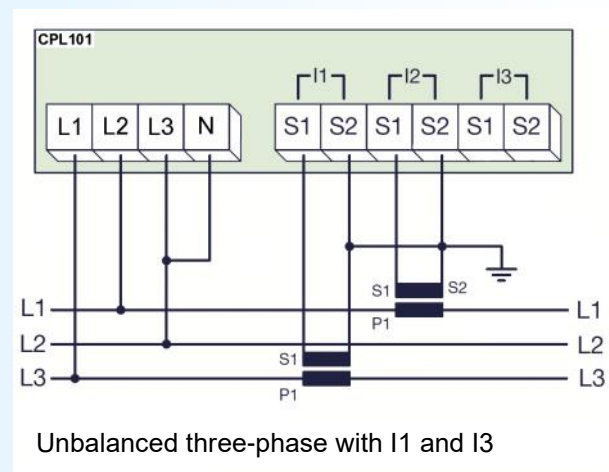

RS232 / DEVICE link

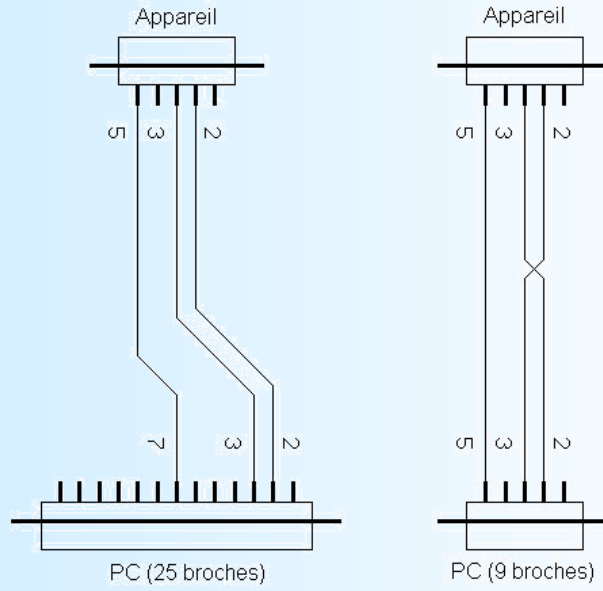

RS485 MODBUS COMMUNICATION

1) Internal structure:

1.1) Presentation:

The device is divided in two cells. Each cell has a specific function while keeping a continuous exchange of pieces of information with the second cell. The first cell is in charge of the measure, analysis and conversion function. The second cell is in charge of the communication function. The information exchange is continuous and automatic.

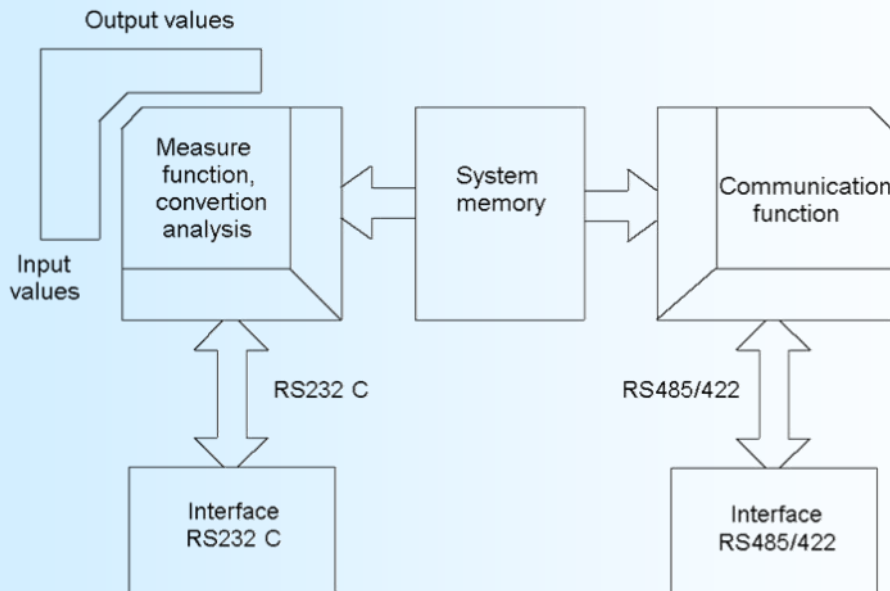

1.2) Measure function:

The measure cell runs the acquisition of the different signals and calculates all the values with regards to the configuration of the device.

It also runs all the output functions (analogical, alarm, meter, RS 232). All measured or calculated parameters are stored in the system memory and are constantly refreshed.

1.3) Communication function:

The communication cell runs the RS485 communication interface in the MODBUS/JBUS protocol. It analyzes the requests of the main station and answers if the device is addressed. It draws all these data from the system memory that can be continuously accessed.

1.4) System memory:

Each cell can continuously access the system memory. The latter has a dual access, which allows a reading/writing of the data without any possible internal conflicts.

2) Communication:

The type of protocol used is: MODBUS/JBUS in RTU mode. The communication has neither header nor delimiter of frame. The detection of the start of frame is made by a silence whose time is at least equal to the transmission of 3.5 bytes. It implies that a frame received can be processed only after a time equal to the silence given before. The time of this silence is directly linked to the speed of transmission of the system:

Ex: Speed 9600 bauds - no parity (10 bits/byte)
 Silence = $(3.5 \times 10) / 9600 = 3.64 \text{ ms}$

The device starts to process the frame 3.64 ms after receiving the last byte.

Note: The time separating two bytes from a same frame must be inferior to a silence. If the user does not comply with this condition, the second byte will be considered as the first one of a new frame.

The interval of time separating the end of reception of the last byte of the question frame and the end of emission of the first byte of the answer frame (detection of frame of the main station) constitutes the answer time of the device.

This answer time T_{rep} includes:

- the silence (time of 3.5 bytes) T_s ,
- the processing of the frame T_t ,
- the emission of the first byte T_{e1} .

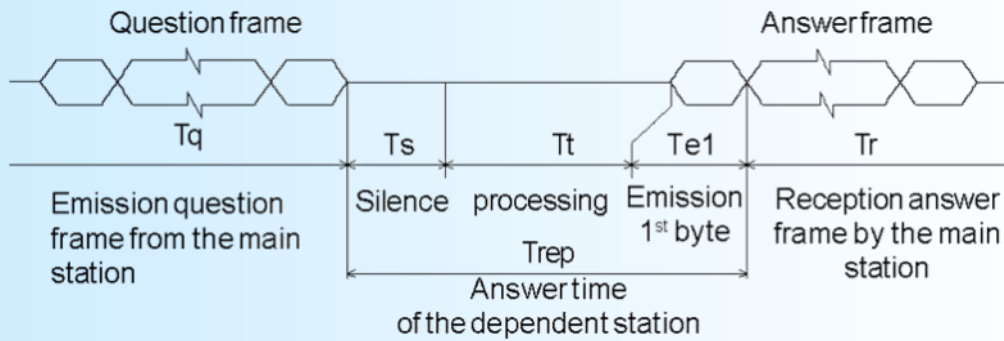

The time beyond which the device does not answer is called **"TIME OUT"**. It depends on the transmission parameters (speed, format) and the type of the function asked (reading, writing). This time must be defined by the user and must be superior to the answer time of the device.

A complete communication cycle includes :

- the question frame transmission T_q
- the device answer time T_{rep}
- the answer frame transmission T_r

Three reasons might cause a TIME OUT:

- wrong transmission data at the question frame time
- wrong configuration of the TIME OUT on the main station
- dependent station out-of-order.

3) Implementation:

3.1) Parameter:

Before starting up the RS485 MODBUS/JBUS communication, make sure that:

- the transmission speed is identical between the dependent stations (LOREME devices) and the main station.
- the parity is identical between the dependent stations (LOREME devices) and the main station.
- the addresses are correctly distributed among the dependent stations (LOREME devices), no identical addresses for two dependent stations.
- the TIME OUT is correctly adjusted on the main station.

All the speed parameters , parity and address must be configured on the devices with the RS232 link.

The devices .configuration possibilities are the following ones:

- address: from 1 to 255
- speed: 600, 1200, 2400, 4800, 9600, 19200, 38400 bauds
- parity: even, odd, none.
- Data format, 32bits floating IEEE, 32 bits integer (lsb or msb first)

3.2) Interconnection:

The RS485 interface used allows to connect 128 dependent stations on the same network. For better operating conditions (noise immunity), the network will have to be made up of a twisted pair.

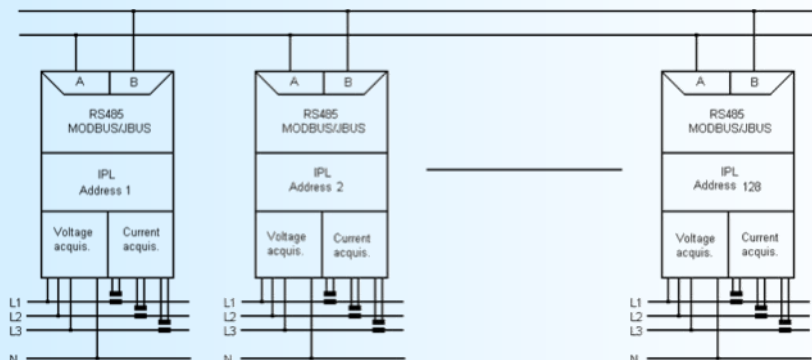

4) Communication time:

4.1) Procedure:

Analysis of the times of communication for parameters of data transmission and for particular cases.

- reading measure phase, energy,
- energy reset,
- speed: 9600 bauds, parity: none.

4.2) Phase measures reading

Reading of 16 words, 32 bytes, from address \$0FFE to \$100D (phase 1)

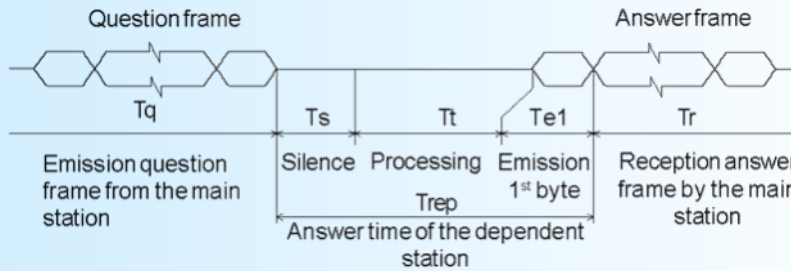

- 8 bytes question frame $Tq = (8 \times 10) / 9600 = 8.33 \text{ ms}$
- Silence $Ts = (3.5 \times 10) / 9600 = 3.64 \text{ ms}$
- Processing $Tt = 60 \text{ ms}$
- Emission 1st byte $Te1 = (1 \times 10) / 9600 = 1.04 \text{ ms}$
- Answer time $Trep = Ts + Tt + Te1 = 64.68 \text{ ms}$
- Answer frame (37 bytes) $Tr = [(37 - 1) \times 10] / 9600 = 37.5 \text{ ms}$
- Complete cycle $Tcyc = Tq + Trep + Tr = 110.5 \text{ ms}$

The processing time Tt is fixed. It depends neither on the speed nor on the transmission format. Consequently, for new transmission parameters, all the times are going to change but for Tt .

To set the **TIME OUT** of the system, you just have to calculate the answer time $Trep$ of the dependent station according to the parameters of communication.

For a total phase reading, the time of cycle of the system is about 110 ms.

4.3) Energies reading

reading of 4 words, 8 bytes, from address \$500C to \$500F (positive energies).

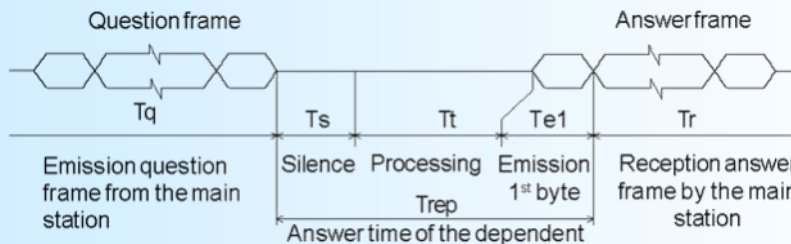

- 8 bytes question frame $Tq = (8 \times 10) / 9600 = 8.33 \text{ ms}$
- Silence $Ts = (3.5 \times 10) / 9600 = 3.64 \text{ ms}$
- Processing $Tt = 60 \text{ ms}$
- Emission 1st byte $Te1 = (1 \times 10) / 9600 = 1.04 \text{ ms}$
- Answer time $Trep = Ts + Tt + Te1 = 64.68 \text{ ms}$
- Answer frame (13 bytes) $Tr = [(13 - 1) \times 10] / 9600 = 12.5 \text{ ms}$
- Complete cycle $Tcyc = Tq + Trep + Tr = 85.51 \text{ ms}$

The processing time Tt is fixed. It depends neither on the speed nor on the transmission format. Consequently, for new transmission parameters, all the times are going to change but for Tt .

To set the **TIME OUT** of the system, you just have to calculate the answer time $Trep$ of the dependent station according to the parameters of communication.

For a energies reading, the time of cycle of the system is about 85 ms.

4.4) Energies reset:

Reset of the active and reactive energies by the writing of word \$55AA at the address \$7000.

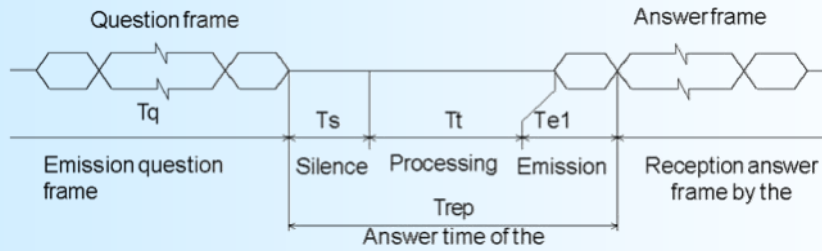

- question frame $Tq = (8 \times 10) / 9600 = 8.33 \text{ ms}$
- silence $Ts = (3.5 \times 10) / 9600 = 3.64 \text{ ms}$
- processing $Tt = 60 \text{ ms}$
- emission 1st byte $Te1 = (1 \times 10) / 9600 = 1.04 \text{ ms}$
- answer time $Trep = Ts + Tt + Te1 = 64.68 \text{ ms}$
- answer frame 8 bytes $Tr = [(8 - 1) \times 10] / 9600 = 7.29 \text{ ms}$
- complete cycle $Tcyc = Tq + Trep + Tr = 80.3 \text{ ms}$

The processing time Tt is fixed. It depends neither on the speed nor on the transmission format. Consequently, for new transmission parameters, all the times are going to change but for Tt .
 To set the TIME OUT of the system, you just have to calculate the answer time $Trep$ of the dependent station according to the parameters of communication.
 For a complete reset of the energies, the time of cycle of the system is about 80 ms.

5) Structure of frames

5.1) Words reading

Function code used : \$03 or \$04

- Phase 1 measure reading: address \$0FFE to \$100D,
- Phase 2 measure reading: address \$1FFE to \$200D,
- Phase 3 measure reading: address \$2FFE to \$300D,
- Network (sum phase) reading: address \$4000 to \$400D,
- Consumed and inductive energy reading: address \$500C to \$500F,
- Generated and capacitive energy reading: address \$600C to \$600F.

Question: 8 byte length frame.

Address dependent	Function Code	Address PF	1 st word Pf	Word PF	value Pf	CRC16 Pf PF	
-------------------	---------------	------------	-------------------------	---------	----------	-------------	--

answer: frame length : 5 byte + number of byte reading. 2 2 2

Address dependent	Function Code	Number of bytes	Words value	CRC16 Pf PF	
-------------------	---------------	-----------------	-------------	-------------	--

5.2) Words writing

Function code used : \$06

Reset of energies: address \$7000 value \$55AA

Question: 8 byte length frame.

Address dependent	Function Code	Address PF	1 st word Pf	Word PF	value Pf	CRC16 Pf PF	
-------------------	---------------	------------	-------------------------	---------	----------	-------------	--

1 1 2 2 2

answer: frame length : 8 bytes.

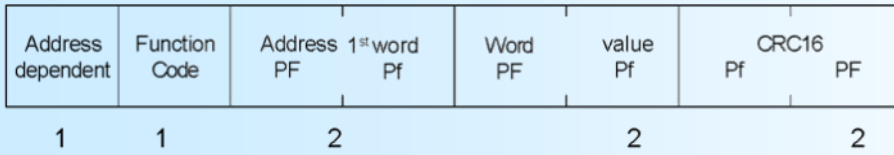

5.3) Exception frame

When a physical error of transmission of a question frame occurs (CRC16 or parity), the dependent station does not answer. If an error of frame (data address, function, value) occurs, an answer of exception will be emitted by the dependent station.

Frame length : 5 bytes.

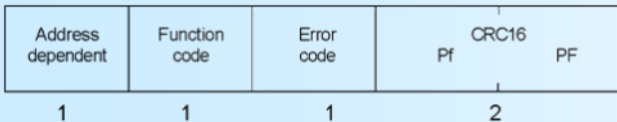

Features of the exception frame:

- Function code: The function code of the exception frame is identical to the one of the question frame, but its bit of strong load is set to 1 (logical or with \$80).

- Error code: Error code establishes the reason of a sending of an exception frame.

Error frame	Meaning
\$01	Function code not used. Only the functions reading of words, \$03 or \$04, writing of a word \$06, or words \$10 are allowed.
\$02	Non-valid data address. Memory access not allowed.
\$03	Non-valid value. Value of word not allowed.

6) Data

6.1) Reading

All measured value are available on reading. Voltage, current, frequency, power, power factor, energies for each phase and for sum of phase (network).

Data are available on this format:

- 2 words (4 bytes) in 32bits floating IEEE or in 32bits signed integer for voltage, current, frequency, active, reactive, apparent powers, cos phi.
- 2 words (4 bytes) in 32bits integer for energies (value in kW.h and kvar.h).

Consult the data table for details.

6.2) Writing

The reset function is made after a write of \$55AA value at address \$7000.

6.3) Data format

- 32bits floating IEEE data

Data send Msb first composed of 2 words (4 bytes).

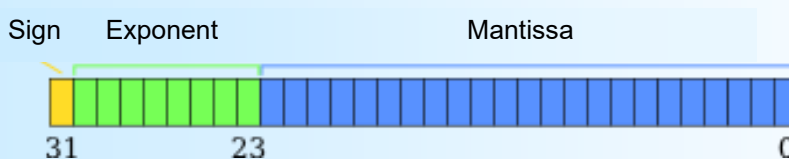

- Data at the format integer 32 bits.
 The data are transmitted with Msb first (direct integer 32 bits) or Lsb first (returned integer 32 bits).
 These data are made of 4 bytes, i.e. 2 words.

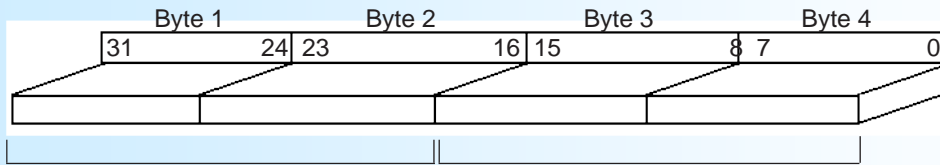

Most significant word Least significant word => Direct
 or
 Least significant word Most significant word => Reverse

Writing data of energy reset is a hexadecimal code. This code is made of 2bytes, i.e.1 word. Code \$55AA: reset of all the energies.

7) Measure tables
7.1) Phase 1 measures

Word Address	Designation	Total Words
\$0FFE	Interlinked voltage	1
	Byte1 Word1	
\$0FFE		2
	Byte2	
\$1000	Star voltage	3
	Byte3 Word2	
\$1001		4
	Byte4	
\$1002	Current	5
	Byte1 Word1	
\$1003		6
	Byte2	
\$1004	Frequency	7
	Byte3 Word2	
\$1005		8
	Byte4	
\$1006	Active power	9
	Byte1 Word1	
\$1007		10
	Byte2	
\$1008	Reactive power	11
	Byte3 Word2	
\$1009		12
	Byte4	
\$100A	Apparent power	13
	Byte1 Word1	
\$100B		14
	Byte2	
\$100C	Cosinus phi	15
	Byte3 Word2	
\$100D		16
	Byte4	

7.2) Phase 2 measures

Word Address	Designation		Total Words
\$1FFE	Interlinked	Byte1 Word1	1
	voltage	Byte2	
\$1FFE		Byte3 Word2	2
		Byte4	
\$2000	Star	Byte1 Word1	3
	voltage	Byte2	
\$2001		Byte3 Word2	4
		Byte4	
\$2002	Current	Byte1 Word1	5
		Byte2	
\$2003		Byte3 Word2	6
		Byte4	
\$2004	Frequency	Byte1 Word1	7
		Byte2	
\$2005		Byte3 Word2	8
		Byte4	
\$2006	Active power	Byte1 Word1	9
		Byte2	
\$2007		Byte3 Word2	10
		Byte4	
\$2008	Reactive power	Byte1 Word1	11
		Byte2	
\$2009		Byte3 Word2	12
		Byte4	
\$200A	Apparent power	Byte1 Word1	13
		Byte2	
\$200B		Byte3 Word2	14
		Byte4	
\$200C	Cosinus phi	Byte1 Word1	15
		Byte2	
\$200D		Byte3 Word2	16
		Byte4	

7.3) Phase 3 measures

Word Address	Designation		Total Words
\$2FFE	Interlinked	Byte1 Word1	1
	voltage	Byte2	
\$2FFE		Byte3 Word2	2
		Byte4	
\$3000	Star	Byte1 Word1	3
	voltage	Byte2	
\$3001		Byte3 Word2	4
		Byte4	
\$3002	Current	Byte1 Word1	5
		Byte2	
\$3003		Byte3 Word2	6
		Byte4	
\$3004	Frequency	Byte1 Word1	7
		Byte2	
\$3005		Byte3 Word2	8
		Byte4	
\$3006	Active power	Byte1 Word1	9
		Byte2	
\$3007		Byte3 Word2	10
		Byte4	
\$3008	Reactive power	Byte1 Word1	11
		Byte2	
\$3009		Byte3 Word2	12
		Byte4	
\$300A	Apparent power	Byte1 Word1	13
		Byte2	
\$300B		Byte3 Word2	14
		Byte4	
\$300C	Cosinus phi	Byte1 Word1	15
		Byte2	
\$300D		Byte3 Word2	16
		Byte4	

7.4) Sum of phases

Word Address	Designation		Total Words
\$4000	Average voltage	Byte1 Word1	1
		Byte2	
\$4001		Byte3 Word2	2
		Byte4	
\$4002	Average current	Byte1 Word1	3
		Byte2	
\$4003		Byte3 Word2	4
		Byte4	
\$4004	Average frequency	Byte1 Word1	5
		Byte2	
\$4005		Byte3 Word2	6
		Byte4	
\$4006	Active power	Byte1 Word1	7
		Byte2	
\$4007		Byte3 Word2	8
		Byte4	
\$4008	Reactive power	Byte1 Word1	9
		Byte2	
\$4009		Byte3 Word2	10
		Byte4	
\$400A	Apparent power	Byte1 Word1	11
		Byte2	
\$400B		Byte3 Word2	12
		Byte4	
\$400C	Cosinus phi	Byte1 Word1	13
		Byte2	
\$400D		Byte3 Word2	14
		Byte4	

7.5) Actives consumed energies, reactive inductive

7.6) Actives generated energies, reactive capacitive

Word Address	Designation		Total Words
\$500C	Consumed active energy	Byte1 Word1	1
		Byte2	
\$500D		Byte3 Word2	2
		Byte4	
\$500E	Reactive inductive energy	Byte1 Word1	3
		Byte2	
\$500F		Byte3 Word2	4
		Byte4	

Word Address	Designation		Total Words
\$600C	Active generated energy	Byte1 Word1	1
		Byte2	
\$600D		Byte3 Word2	2
		Byte4	
\$600E	Reactive capacitive energy	Byte1 Word1	3
		Byte2	
\$600F		Byte3 Word2	4
		Byte4	

Note: The address range \$5000 to \$500B and \$6000 to \$600B are available but they don't have usable data (they are reserved for later use)